

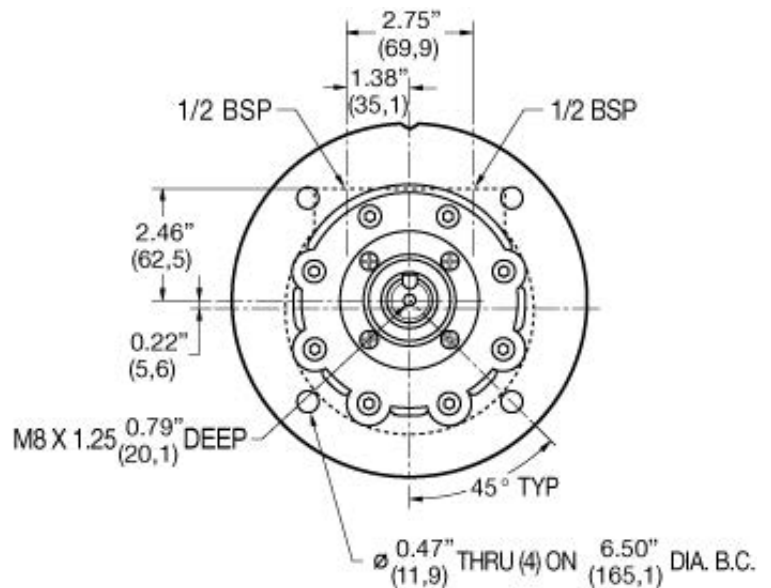

Technical Specifications

Power Type:	Pneumatic
Horsepower (KW):5 (3,7)
Air Consumption:	170 CFM (80 l/sec) @ 100 psi (7 bar)
Air Inlet / Exhaust Size:	1/2" bsp(f) / 1/2" bsp(f)
Housing Material:	Cast Steel
Frame:	IEC #72/D90
Noise Level:	105 dBa
Lubrication Required:	Yes, Daily
Weight:	26 lbs (11,8 kg)

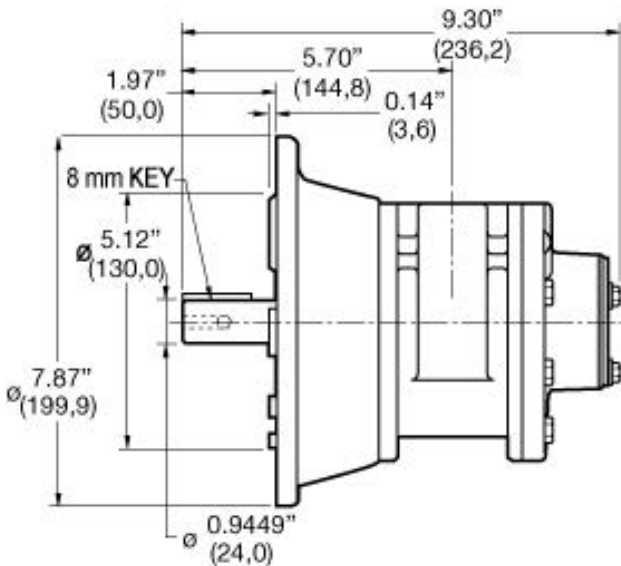

Note: Only compatible with the SP-700DD or 800DD Series pump.



WARNING: Pumping of flammables or combustible liquids can generate a static electric discharge, causing fire or explosion resulting in injury or death. Read and understand operating instructions before starting this unit. Follow all federal, state and local safety codes including NFPA 30 - NFPA77. Prior to connecting to air supply, install bond and ground wires and check continuity of each wire. A meter reading of one ohm or less is required for safe liquid transfer. Use only metallic drum, receiving vessel and metallic pump when pumping flammables. Air motors are not recognized under any current Underwriter's Laboratory listing program. Consult a qualified engineer for suitability for use in a hazardous area or on flammables.